

K900S CHIPPING HAMMER IN2

4933375720 - K900S - 4000375721

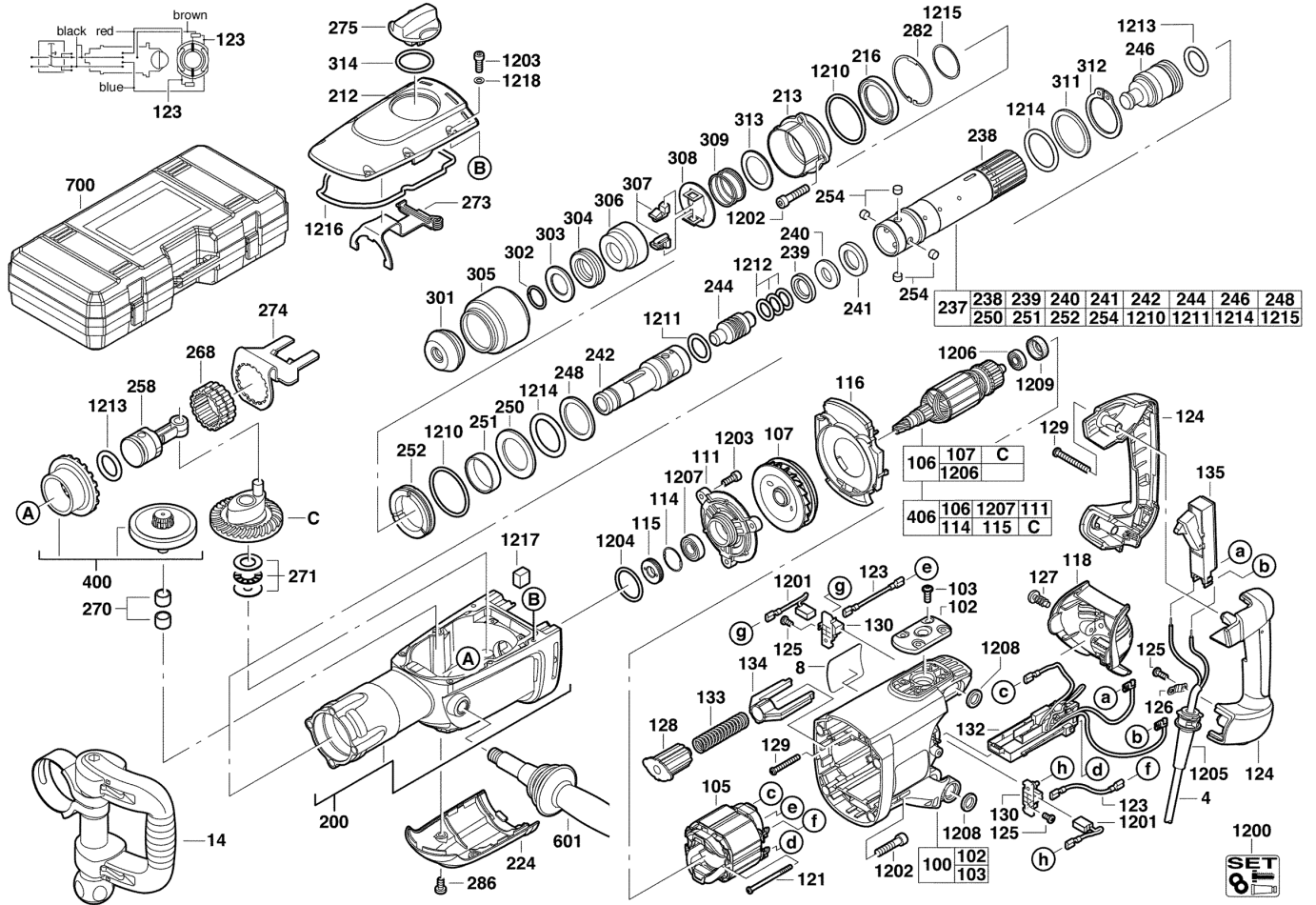

Position	Quantity	Description	Part number	EAN
0004	1	CONNECTION CABLE	4931624696	4002395800872
0008	1	RATING PLATE	4931375723	4002395737116
0014	1	HANDLE	4931398534	4002395776658
0100	1	MOTOR HOUSING	4931375740	4002395735723
0102	1	SECURED WASHER	4931375531	4002395711574
0103	4	SCREW	4931624213	4002395736096
0105	1	ELECTRIC FIELD	4931442746	4002395885244
0106	1	ARMATURE	4931432415	4002395899418
0107	1	FAN	4931375474	4002395711536
0111	1	BEARING END PLATE	4931426434	4002395842483
0114	1	LOCKING RING	4931890311	4002395706297
0115	1	SEAL RING	4931375489	4002395711543
0116	1	AIR DEFLECTOR RING	4931375515	4002395731756
0118	1	SERVICING LID	4931375535	4002395731787
0121	2	SCREW	4931339996	4002395623976
0123	2	WIRE	4931624263	4002395724819
0124	1	PAIR HANDLE SHELLS	4931375560	4002395731817
0125	4	SCREW	4931624538	4002395760039
0126	1	CABLE COLLAR	4931256500	4002395586547
0127	2	SCREW	4931624537	4002395760022
0128	1	THRUST PIECE	4931375477	4002395731701
0129	5	SCREW N874101-1 SHR C-K5X45/20 KOMBITORX	4931622765	4002395699094
0130	2	BRUSH HOLDER	4931381694	4002395780303
0132	1	ELECTRONIC	4931409105	4002395791590
0133	1	PRESSURE SPRING	4931375529	4002395711550
0134	1	TRANSITION PIECE	4931375530	4002395711567
0135	1	SWITCH	4931375454	4002395731688
0200	1	GEAR BOX	4931412436	4002395798995
0212	1	GEAR BOX COVER	4931426458	4002395850273
0213	1	SEAL RETAINER	4931375569	4002395731824
0216	1	SEAL RING	4931624205	4002395714285
0224	1	GEAR COVER	4931375443	4002395711611
0237	1	SPINDLE	4931375378	4002395731510
0238	1	SPINDLE SLEEVE	4931426172	4002395903276
0239	1	BACK-PRESSURE RING	4931375411	4002395731565
0240	1	BACK-PRESSURE RING	4931375412	4002395731572
0241	1	ATTACHMENT RING	4931409791	4002395841486
0242	1	DRIVER	4931426173	4002395876563
0244	1	SNAP DIE	4931375573	4002395720354
0246	1	PERCUSSION BODY	4931375782	4002395741298
0248	1	ATTACHMENT RING	4931375416	4002395731596
0250	1	WASHER	4931375418	4002395736003
0251	1	BALL RACE	4931375419	4002395731602
0252	1	THRUST COLLAR	4931375420	4002395731619
0254	4	DRIVER	4931375787	4002395741977
0258	1	PISTON COMPL.	4931375380	4002395731534
0268	1	SET COLLAR	4931396199	4002395748884
0271	1	THRUST BEARING	4931409549	4002395815418
0273	1	ADJUSTING PLATE	4931375583	4002395726493
0274	1	LOCKING PLATE	4931375401	4002395717064

Position	Quantité	Désignation	Référence	EAN
0275	1	LEVER	4931375546	4002395731794
0282	1	RETAINING RING	4931624235	4002395717460
0286	2	SCREW	4931624658	4002395790975
0301	1	END COVER CAP	9170350243	4002395577330
0302	1	SPRING RING	9170319040	4002395571895
0303	1	DAMPING ELEMENT	4931409820	4002395834778
0304	1	DAMPING RING	4931375775	4002395739943
0305	1	Chuck Cover	9170316570	4002395570959
0306	1	INTERLOCK SLEAVE	4931409842	4002395844739
0307	2	INTERLOCK ELEMENT	4931375769	4002395739196
0308	1	INTERLOCK PLATE	4931375770	4002395739202
0309	1	PRESSURE SPRING	4931375594	4002395736423
0311	1	ATTACHMENT RING	4931375509	4002395731749
0312	1	RETAINING RING	4931624203	4002395714278
0313	1	DISC	4931375595	4002395739950
0314	1	O-RING N874701 26X3	4931622166	4002395696963
0400	1	REPAIR KIT	4931432420	4002395899449
0406	1	REPAIR KIT	4931432415	4002395899418
0601	1	HANDLE	4931375516	4002395736027
0700	1	CARRYING CASE	4931400760	4002395765256
1200	1	MAINTENANCE SET	4931375659	4002395733927
1201	1	CARBON BRUSH SET	4931375556	4002395720323
1202	8	SCREW	4931624234	4002395717453
1203	9	SCREW D 912 M5X16 8.8SSI	4931624276	4002395727858
1204	1	SEAL RING	4931624237	4002395717484
1205	1	PROTECTING COVER	4931392174	4002395772872
1206	1	BALL BEARING	4931341741	4002395627004
1207	1	GROOVED BALL BEAR.	4931398189	4002395767304
1208	4	SEAL RING	4931624170	4002395710904
1209	1	RUBBER SLEEVE	4931317212	4002395599806
1210	2	SEAL RING N874701 28X5	4931624156	4002395731879
1211	1	SEAL RING N874701 28X5	4931624161	4002395731909
1212	3	SEAL RING N874701 28X5	4931624155	4002395731862
1213	2	SEAL RING N874701 28X5	4931624158	4002395731893
1214	2	SEAL RING N874701 28X5	4931624157	4002395731886
1215	1	SPRING RING N874268 SW 20	4931624153	4002395731855
1216	1	GASKET	4931375506	4002395731725
1217	1	FELT	4931375508	4002395731732
1218	6	SEALING WASHER	4931603515	4002395693481